

DEUTSCHES PATENT- UND MARKENAMT

80297 München

Telephone: (49 - 89) 21 95 - 0

Telefax: (49 - 89) 21 95 - 22 21

Telephone enquiries: (49 - 89) 21 95 - 34 02

Internet: <http://www.dpma.de>

Beneficiary:

Bundeskasse Weiden

BBk München 700 010 54 (Bank sort code: 700 000 00)

BIC (SWIFT Code): MARKDEF1700

IBAN: DE84 7000 0000 0070 0010 54

- Dienststelle Jena -

07738 Jena

Telephone: (49 - 36 41) 40 - 54

Telefax: (49 - 36 41) 40 - 56 90

Telephone enquiries: (49 - 36 41) 40 - 55 55

- Technisches Informationszentrum Berlin -

10958 Berlin

Telephone: (49 - 30) 25 992 - 0

Telefax: (49 - 30) 25 992 - 404

Telephone enquiries: (49 - 30) 25 992 - 220

Procedures to file a request to the DPMA for Patent Prosecution Highway Pilot Program between the DPMA and the JPO

1. The outline of the Patent Prosecution Highway Pilot Program

The Patent Prosecution Highway (PPH) pilot program enables an application whose claims have been determined to be patentable in the Office of First Filing (OFF) to undergo an accelerated examination in the Office of Second Filing (OSF) with a simple procedure according to a request from an applicant.

2. Request to the DPMA

An applicant has to file a request for accelerated examination under the Patent Prosecution Highway (PPH) to the DPMA in German language by submitting a form for requesting accelerated examination under the PPH pilot program accompanied by the relevant supporting documents. The requirements for an application to the DPMA for accelerated examination under the PPH are given in the following section (paragraph 3). Relevant supporting documentation is discussed in a later section (paragraph 4) as is the general DPMA application procedure envisaged at this time (paragraph 5).

3. Requirements for requesting accelerated examination under the PPH Pilot Program at the DPMA

There are four requirements for requesting accelerated examination under the PPH pilot program at the DPMA. These are:

a) Either:

- i) the DPMA application (including PCT national phase application in Germany) validly claims priority under the Paris Convention from either a single corresponding JPO application or multiple JPO applications (examples are

provided in Annex figures A, B, G, H and J);
or

- ii) the DPMA application arises from a PCT national phase application without priority claims for which the national phase was initiated in Japan (examples are provided in Annex figure K)
 - iii) the DPMA application validly claims priority under the Paris Convention to the PCT international application(s) for which the national phase was initiated in Japan (examples are provided in Annex, figures L, M and N) or
 - iv) the DPMA application is a divisional of an application met in the above i), ii) or iii).
- b) At least one corresponding JPO application has one or more claims that have been determined to be patentable by the JPO.
- c) All claims in the DPMA application for accelerated examination under the PPH must sufficiently correspond to one or more of those claims indicated as patentable in the JPO. Claims shall be considered to sufficiently correspond where the claims are of the same scope such that the claims in the DPMA application have a common technical feature with the claims in the JPO application which makes the claims allowable over the prior art in the corresponding JPO application. Where amended claims have been determined to be patentable by the JPO, the claims of the DPMA application should be such that they correspond to the amended claims of the JPO application. Claims of the DPMA application which are appended to earlier claims of the DPMA application corresponding to claims that are indicated as patentable by the JPO will also be considered where such claims fall within the scope of the claims indicated as patentable by the JPO.

- d) The DPMA has not begun examination of the application.

4. Required documents for accelerated examination under the PPH Pilot Program at the DPMA

The following documentation will be needed to support a request for accelerated examination under the PPH pilot program at the DPMA:

- a) a copy of all office actions on the corresponding JPO application(s) and translation of them. Both German and English are acceptable as translation languages. No paper copy and corresponding translation of the office actions need be supplied if the office actions are available on AIPN¹. However, if the available (machine) translation is insufficient, the DPMA examiner may request an additional translation from the applicant.
- b) a copy of the claims examined by the JPO and copies of subsequent amended claims found to be patentable by the JPO where appropriate, and translation of them. Both German and English are acceptable as translation languages. No paper copy or translation of the claims need be supplied if the claims are available on AIPN. However, if the available (machine) translation is insufficient, the DPMA examiner may request an additional translation from the applicant.
- c) a completed claim correspondence table in German language showing the relationship between the claims of the DPMA application for accelerated examination under the PPH and the claims of the corresponding JPO application considered patentable by the JPO. Sufficient correspondence of claims occurs where the claims are of the same scope as defined above. When claims are just literal translation, the applicant can just write down that "they are same" in the table. When claims are not just literal translation, it is necessary to explain the sufficient correspondence of each claim based on the criteria 3c).
- d) a copy of the document(s) cited by the JPO examiner in the reasons for refusal.

If the cited document is a patent document it does not have to be submitted as it is generally available to the DPMA either via DEPATIS, EPOQUE or AIPN. Where the DPMA has difficulty in obtaining a patent document the Office will ask the applicant to submit it.

As a rule, cited documents need not be translated.

The applicant has to provide the relevant information by filling in a form for requesting accelerated examination under the PPH pilot program which will be made available for download from the DPMA website. The form should be sent to the DPMA along with the relevant supporting documentation.

If the applicant has already submitted the above documents a) to d) to the DPMA through simultaneous or past procedures, the applicant can incorporate the documents by reference and does not have to attach them.

5. Procedure for accelerated examination under the PPH Pilot Program at the DPMA

The applicant files a form requesting accelerated examination under the PPH pilot program to the DPMA, including the relevant supporting documents. If the requirements are met, the DPMA will conduct the accelerated examination. If the application does not qualify for participation in the PPH project, the applicant will be informed accordingly and the application will be further processed under the standard DPMA examination procedure, without acceleration.

¹ AIPN is a network between patent offices which provides JPO's file wrapper information. Applicants do not have access to AIPN, but if you want to know whether information about your application is available on the AIPN, please ask the JPO (PA2260@jpo.go.jp).

Annexes:

A A case meeting requirement (a) (i)
- Paris route -

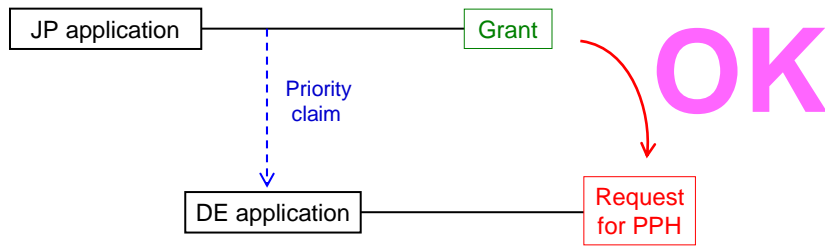

B A case meeting requirement (a) (i)
- PCT route -

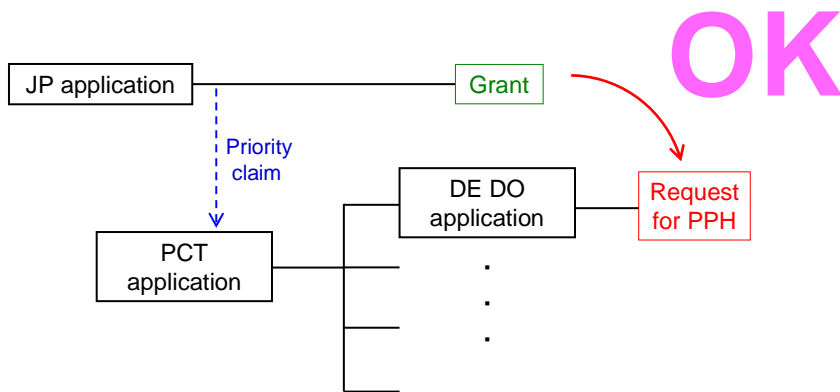

C A case not meeting requirement (a)
 - Paris route, but the first application is from the third country -

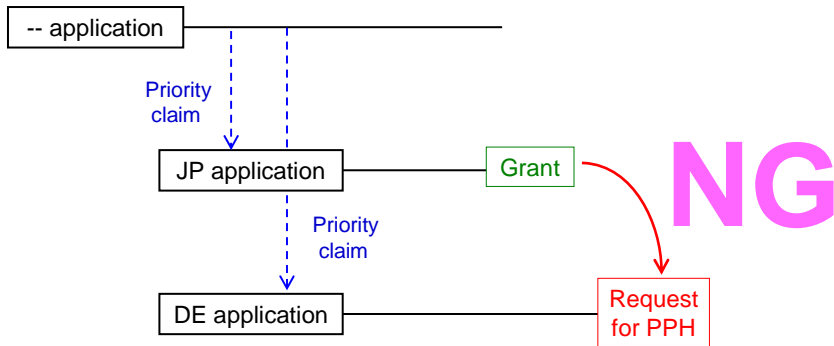

-- : the office other than the JPO

D A case not meeting requirement (a)
 - PCT route, but the first application is from the third country -

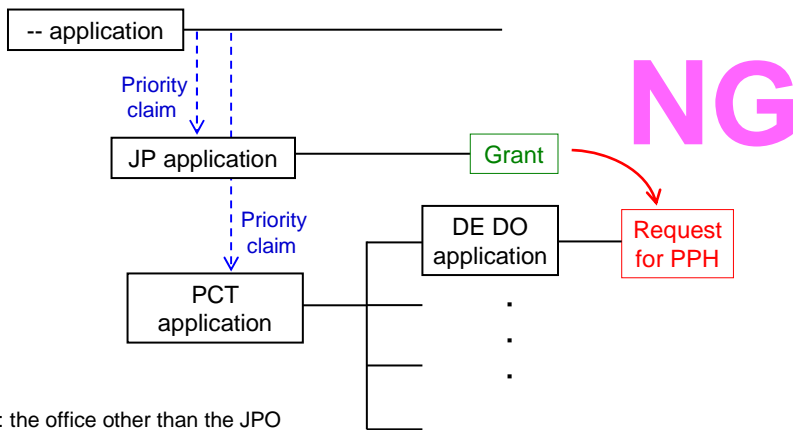

-- : the office other than the JPO

E A case not meeting requirement (b)
- Search Report -

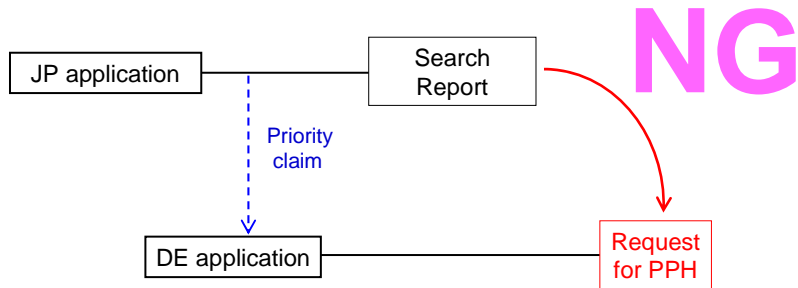

F A case not meeting requirement (b)
- ISR, ISO -

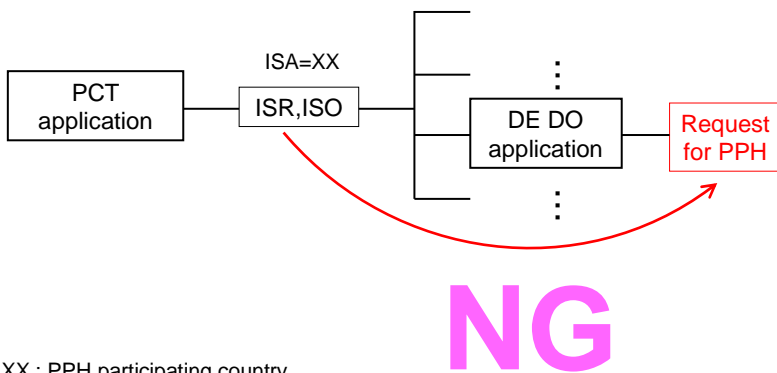

XX : PPH participating country

G A case meeting requirement (a) (i)
- Paris route & Complex priority -

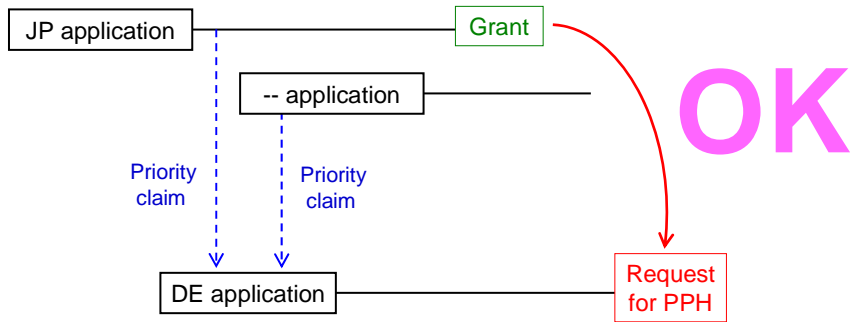

-- : any office

H A case meeting requirement (a) (i)
- Paris route & Internal priority -

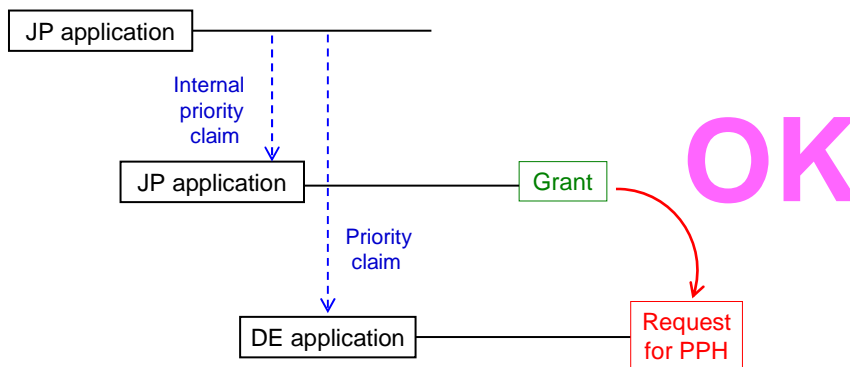

I A case meeting requirement (a) (i)
- Paris route & divisional application -

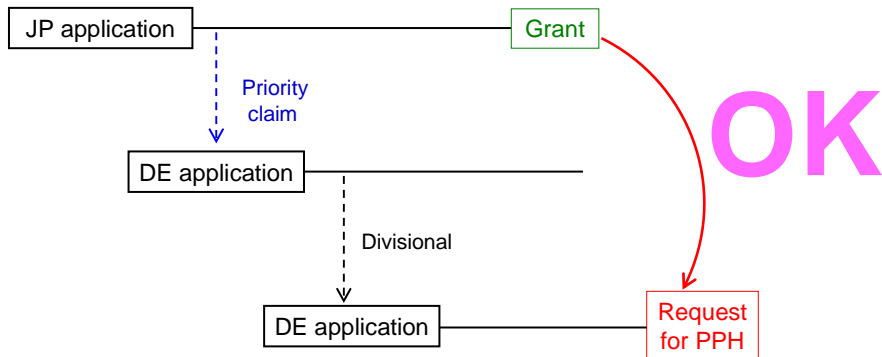

J A case meeting requirement (a) (i)
- PCT route -

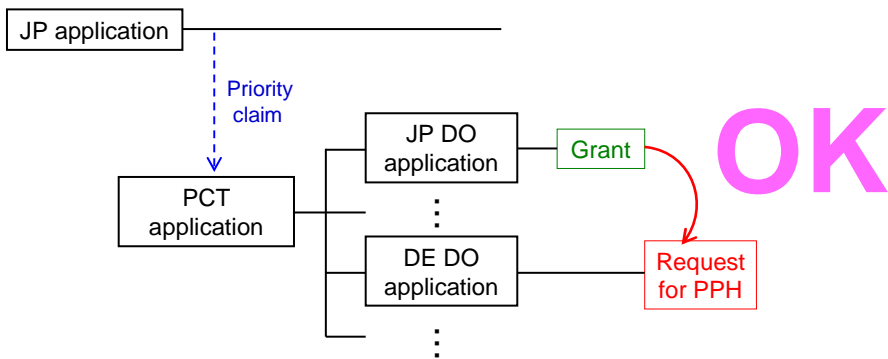

K

A case meeting requirement (a) (ii)
- Direct PCT route -

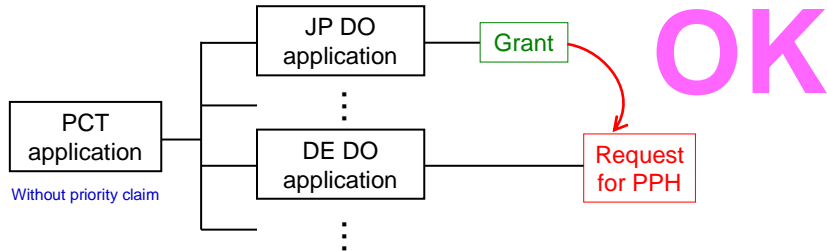

L

A case meeting requirement (a) (iii)
- Direct PCT & Paris route -

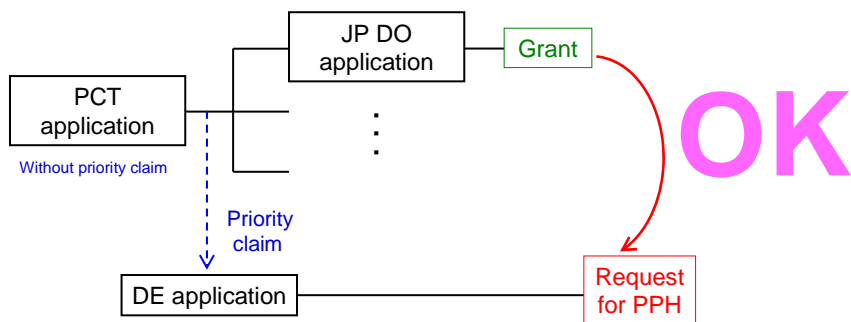

M A case meeting requirement (a) (iii)
- Direct PCT & PCT route -

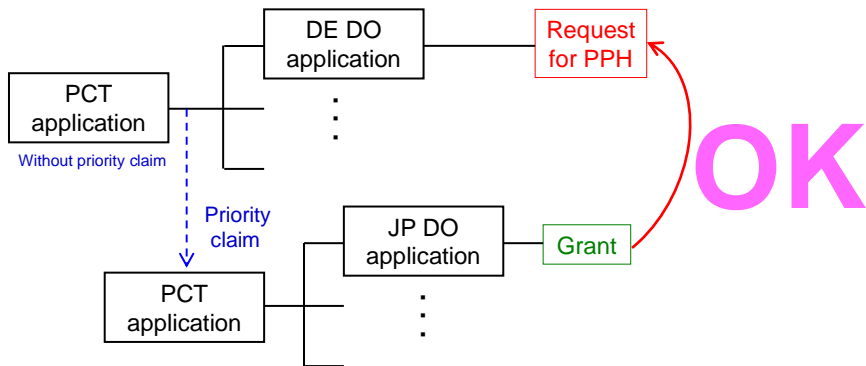

N A case meeting requirement (a) (iii)
- Direct PCT & PCT route -

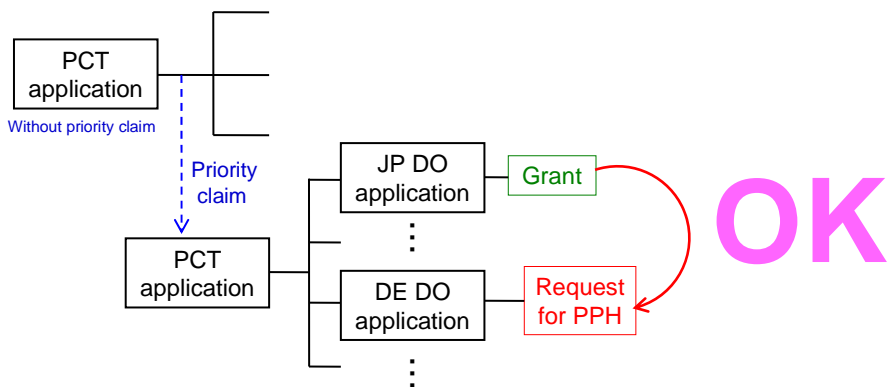

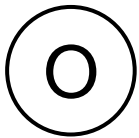

A case not meeting requirement (d)
- Examination has begun before a request for PPH -

